

Introduction

Your Veeder-Root brand C628 Rate Meter is one model in a family of 1/8 DIN units which offers breakthrough display technology as well as easy-to-program single-line parameters. Designed to provide instant visual feedback regarding an application's key input value, the C628 not only has a 0.71" high LED display (27% larger than other 1/8 DIN units), but also the ability to change display color based on process status (programmable parameter in Operation Mode). Easy programming is made possible via a help function and a secondary legend display.

This manual will guide you through the installation and wiring of your C628 unit with information on proper panel mounting and rear terminal layout and wiring instructions. In addition, the instrument's operation and programming modes are thoroughly explained. The Operation Mode provides day to day operation and allows editing of preset values. The Program Mode enables the configuration of various parameters prior to initial operation. These parameters include those for basic configuration as well as other settable features which will enhance the functionality and usability of the device.

This manual also provides information on the C628 Rate Meter's alarms; transistor, relay and linear outputs; product specifications; and ordering and warranty procedures.



Features

- AWESOME 0.71" high digit LED display
- Programmable color change display based on an event
- Programmable help function and secondary legend display
- Display configurable for update time, min. number of pulses, and forced zero time
- Optional linear output relative to rate
- Choice of NPN, PNP, or magnetic primary input
- Filter speed settable for 20, 200, or 10,000 Hz
- Standard outputs: two NPN transistors & one relay (optional 2nd relay)
- Front panel reset enable and alarm lockout
- Optional RS-485 plug in card
- CE approved

Index

| | |
|----------------------|-----------|
| Installation | |
| Panel Mounting | page 2 |
| Wiring | page 3 |
| Operation | |
| Front Panel | page 4 |
| Operation Mode | page 5 |
| Programming | |
| Program Mode | page 6-10 |
| Appendix A | |
| Specifications | page 11 |
| General | |
| Ordering Information | page 12 |
| Warranty | page 12 |

*Technical Manual
702138-0003*

Veeder-Root brand
Series C628
Rate Meter
(C628-4XXX)

INSTALLATION

PANEL MOUNTING

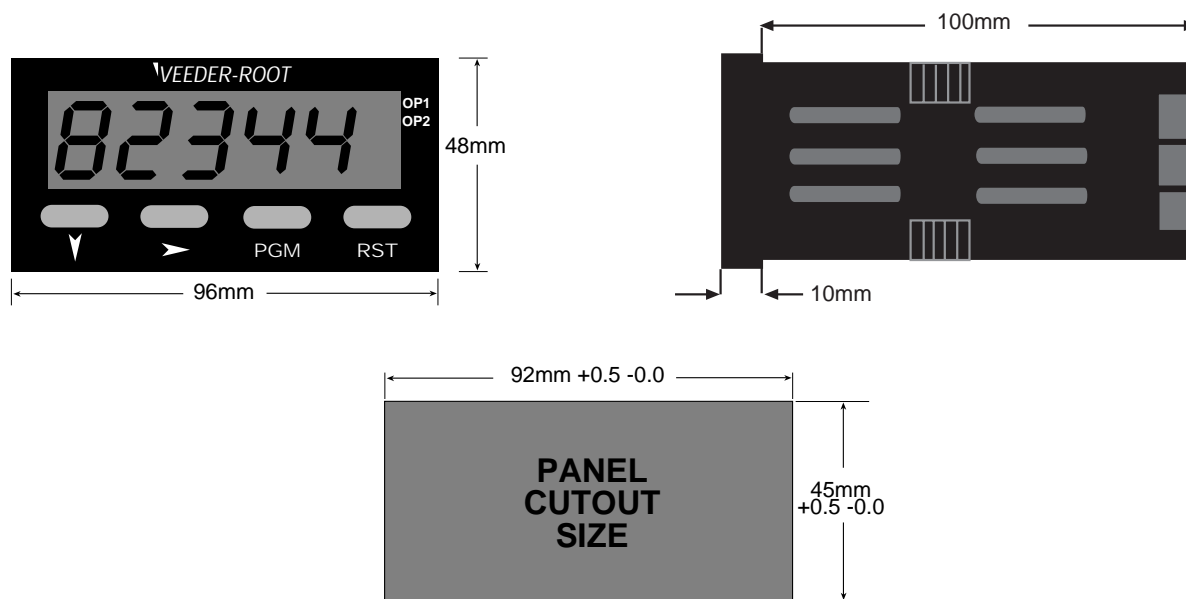

The instrument can be mounted in a panel with a thickness of up to 6mm. The cutout(s) should be made based on the recommended panel opening illustrated in the drawing above.

Mounting Grooves

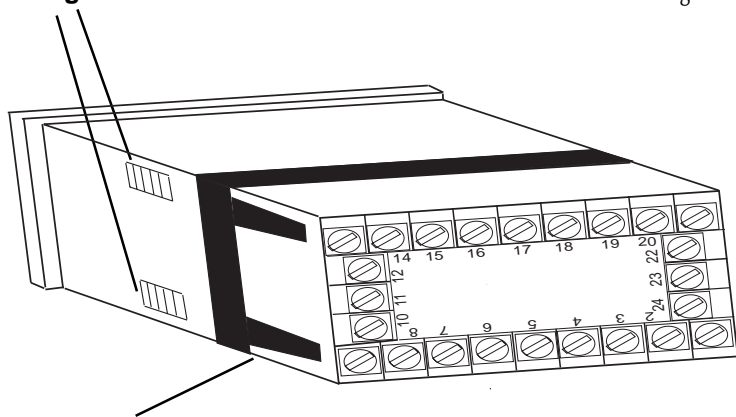

Insert the unit in the panel through the cutout. Ensure that the panel gasket is not distorted and the instrument is positioned squarely against the panel. Slide the mounting clamp into place on the instrument, as shown to the left, and push it forward until it is firmly in contact with the rear face of the mounting panel and the tabs on the bracket arm are seated in the mounting grooves on the side of the unit.

The electronic components of the instrument can be removed from the housing after installation without disconnecting the wiring. To remove the components, grip the side edges of the panel and pull the instrument forward. Take note of orientation of the unit for subsequent replacement in the housing.

Bracket Arm

WIRING

REAR TERMINAL CONNECTIONS

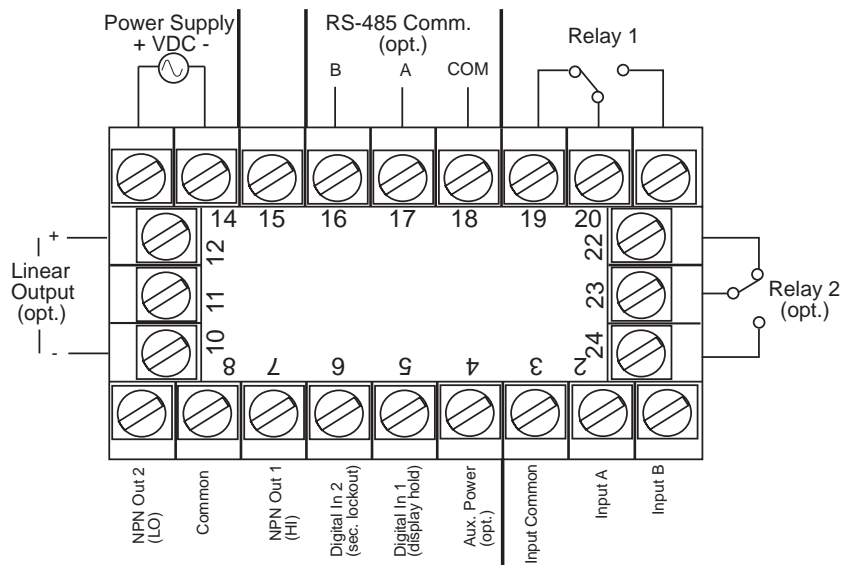

Input Power

For an AC powered unit, Terminal #13 serves as the line or Hot side connection for AC powered units and as the positive side for DC powered units. The neutral side for AC powered units and the negative side for DC powered units are connected to Terminal #14.

Count Inputs

Terminal #2 is the connection for Input A, which is programmable to be the primary rate channel. Terminal #1 is the secondary input to get the ratio of A/B. The common connection for both inputs is Terminal #3.

Control/Digital Inputs

A contact closure or NPN signal can be used to activate preconfigured functionality. Terminal #5 is used for a display hold function, while Terminal #6 is a security function, that when active, will prohibit entry into Program Mode. Terminal #8 serves as the common for both of these inputs.

Auxiliary Power Output

A 9 - 15 VDC for powering external sensors and encoders up to 125 mA can be accessed by connecting the positive supply side of the sensor to Terminal #4 and the negative side to Terminal #8.

Linear Output

An option board may be installed that provides a 10 bit linear output signal relative to the Rate Value. Terminal #12 is the positive side of the connection, and Terminal #10 is the negative side. The default range of the output is 4-20 mA, but can be changed via the front panel to 0-20 mA, 0-10 VDC, 2-10 VDC, 0-5 VDC, or 1-5 VDC.

Transistor Outputs

Your unit comes standard with 2 NPN outputs which are activated by each of the alarms. Transistor Output 1, which is tied to the High Alarm Value, is on Terminal #7. Transistor Output 2, which is tied to the Low Alarm Value, is on Terminal #9. Terminal #8 serves as the common connection for both transistor outputs.

Relay Outputs

Your unit comes standard with a relay output which is tied to the High Alarm Value. Terminal #19 is NC, Terminal #20 is common, and Terminal #21 is NO. A second relay output tied to the Low Alarm Value can be added as an option at the time of order or later installed in the field. Terminal #22 is NC, Terminal #23 is common, and Terminal #24 is NO.

Serial Communication

An RS-485 communication board, utilizing ASCII protocol, can be installed as an option. Terminals #16 & #17 serve as the B and A connections respectively, while Terminal #18 is connected as the common.

Terminals 11 & 15 are not used.

OPERATION

FRONT PANEL

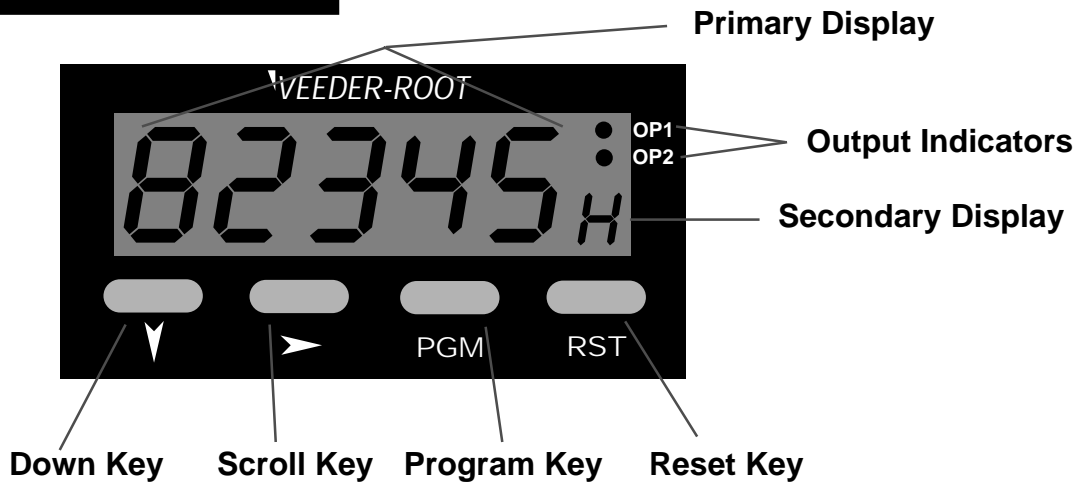

Key Functions

| Key | Function |
|------------------------|---|
| Down | <i>In Operation Mode:</i> Used in edit operation to decrement the digit highlighted by the Scroll key. <i>In Program Mode:</i> Used in Edit Operation to decrement the digit highlighted by the Scroll key, if the setting is a numerical value, or present the next in the series of choices for that parameter. |
| Scroll | <i>In All modes:</i> Moves the unit into Edit Operation, which is indicated by the left most digit flashing. Successive presses of the key are used to move to the digit to be edited. Wrap around will occur from least significant digit to most significant digit. |
| Program | <i>In Operation Mode:</i> Used to move between the rate value display, process time display, & the alarms and to enter an edited alarm value. Holding the key down for 3 seconds will cause the unit to enter Program Mode. <i>In Program Mode:</i> Used to move from one parameter to the next and enter the edited parameter values. Holding the key down for 3 seconds will cause the unit to return to Operation Mode. |
| Reset | <i>In All modes:</i> No function. |
| Down & Scroll together | <i>In All modes:</i> Will abort an Edit Operation and return the alarm/parameter to its previous value. |

Display Functions

| Display | Function |
|-------------------|--|
| Primary | <i>In Operation Mode:</i> Default display is the rate value. Can be scrolled using the program key to display the process time and alarm values. If the "Help" function is enabled, this display will first show the parameter description for 3 seconds (see page 5 for example). <i>In Program Mode:</i> Displays the value or selection for the current parameter. If the "Help" function is enabled, this display will first show the parameter description for 3 seconds (see page 6 for example). |
| Secondary | <i>In Operation Mode:</i> Indicates alphabetically which parameter is being viewed on the primary display. <i>In Program Mode:</i> Provides a 1 digit alpha or numeric character to indicate which parameter value is being shown on the primary display. |
| Output Indicators | <i>In Operation Mode:</i> OP1 illuminates when Output 1 is active. OP2 illuminates when Output 2 is active. <i>In Program Mode:</i> No function. |

OPERATION

OPERATION MODE

CHANGING A PARAMETER VALUE



Default display is the rate value.

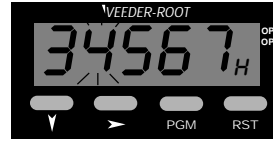

Use the Scroll Key to move from left to right and highlight the digit that needs to be changed. Wrap around will occur from the least significant to the most significant digit.



Pressing the Program Key will cause the display description to appear on the main display.* If there is no key activity for 3 seconds, the primary display will switch back to the rate value.



Use the Down Key to decrement the digit until the desired value appears. The display will wrap around from 0 to 9.



Continued pressing of the Program Key will scroll through the Parameters. (See Parameter Sequence below.) The full parameter description will appear on the main display.*

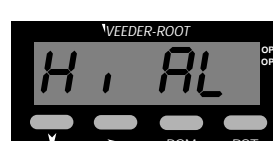

After the desired digits have been changed, press the Program Key to enter the new value. The new value will appear on the main display without any flashing digits. Press the Program Key again and the parameter description will appear on the main display.



To change a Parameter value, press the Scroll Key. If there was no key activity for 3 seconds, the Preset value will appear (one digit description shown on secondary display); however, press the Scroll Key in order to edit. The unit will now be in Edit Operation as signified by the most significant digit flashing.**

* Parameter descriptions will not appear on the primary display if the "Help" function has been disabled.

** Edit Operation cannot be accessed if the Preset Lock has been enabled in Program Mode.

PARAMETER SEQUENCE

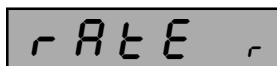

Rate Value

Function: Displays present rate value
Range: 0 to 99999

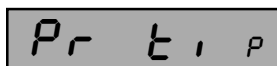

Process Time

Function: Displays present process time (an inverse speed calculation)
Range: 0 to 99999



[can indicate travel time through a conveyORIZED oven]



High Alarm Value

Function: Defines the rate value at or above which Alarm 1 will activate
Adjustment Range: 0 to 99999
Default Value: 1000



Low Alarm Value

Function: Defines the rate value at or below which Alarm 2 will activate
Adjustment Range: 0 to 99999
Default Value: 10

PROGRAMMING

PROGRAM MODE

ENTERING PROGRAM MODE AND BASIC OPERATION

The Program Mode can be accessed from the Operation Mode by holding the Program Key for 3 seconds.

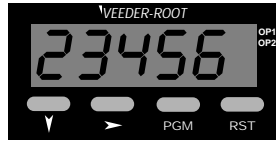

PGM for 3 seconds

The name of the first parameter will appear on the primary display.*

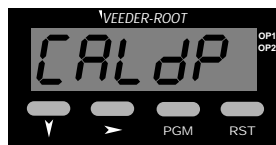

PGM

Successive presses of the Program Key will scroll the display through the remaining parameters in the Program Mode. To exit Program Mode, hold the Program Key for 3 seconds.



no key activity for 3 secs. or

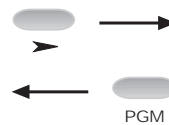

Edit Operation

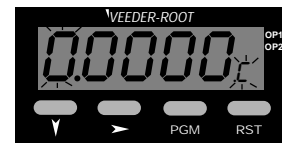

Pressing the Scroll Key or no key activity for 3 seconds will display the value for that parameter. The secondary display will indicate the one digit identifier for the parameter. The digit in the secondary display will flash to indicate the unit is in Program Mode. If the Scroll Key was pressed (instead of waiting 3 seconds), the unit is in Edit Operation, as indicated by the MSD flashing. If there had been no key activity for 3 seconds, press the scroll key to enter Edit Operation (MSD flashing). Use the scroll and edit buttons to change the value as in Operation Mode, described on page 5. Press the Program Key to enter any changes.

* Parameter names will not appear on the main display if the "Help" function has been disabled in Program Mode.

PARAMETER SEQUENCE

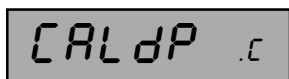

PGM

Calibration Factor Decimal Point

Function: Sets the decimal point position for the calibration factor display

Adjustment Range: 0 to 0.0000

Default Value: 0.0

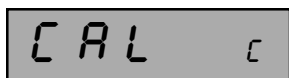

PGM

Calibration Factor

Function: Used to scale the input into engineering units by multiplying this value by the input frequency

Adjustment Range: 0.0001 to 9.9999

Default Value: 1.0000

PROGRAM MODE Continued

d E c P d



Decimal Position

Function: Set the decimal point position for the rate and preset displays

Adjustment Range: 0 to 0.0000

Default Value: 0

r A t P r



Rate Mode

Function: Defines how the input pulses will be applied to the rate value

Adjustment Range:

A

A_b

A t . P r

A: Inputs on the A channel increment the total

A/B: Divides the rate of the A channel by the rate of the B channel to display a ratio between the inputs

A Time: Displays the frequency of Input A as an inverse speed which, for example, can indicate travel time through a conveyORIZED oven

Default Value: A

Input,



Input Type

Function: Programs the unit to match the electrical characteristics of the input signal

Adjustment Range:

S in

S r c

P r A G

Sinking: The unit will accept a NPN or dry contact input which sinks voltage to common

Source: The unit will accept a PNP input which sources voltage

Magnetic: The unit will accept a magnetic input from 0.5 to 30V peak

Default Value: Sinking

S P E E D F



Filter Speed

Function: Enables the debounce filter of the meter to properly match the application

Adjustment Range:

20

200

10000

20: The unit will accept up to 20 pulses per second. Generally used with contact inputs to eliminate false counts caused by contact bounce

200: The unit will accept up to 200 pulses per second. Generally used for higher speed contact inputs or to filter noise on electronic signals in low speed applications

10,000: The unit will accept up to 10,000 pulses per second. Generally used with high speed electronic inputs and encoders

Default Value: 10000

PROGRAM MODE Continued

uPdAt U

PGM

Display Update Time

Function: Sets the amount of time between display updates

Adjustment Range:

0.1

0.1 sec.

0.25

0.25 sec.

0.5

0.5 sec.

1 to 10

1 to 10 sec.

Default Value: 1

0 t, 0

PGM

Display to Zero Time

Function: Displays minimum input frequency by setting the amount of time after no pulses are received, when the display will show zero

Adjustment Range:

0.1

0.1 sec.
(10 Hz.)

0.25

0.25 sec.
(4 Hz.)

0.5

0.5 sec.
(2 Hz.)

1 to 10

1 to 10 sec.
(1 Hz to 0.1 Hz)

Default Value: 1

Pu 15 P

PGM

Minimum Pulses

Function: Sets the minimum number of pulses to be received before the display will update the rate value.

Note: Display Update Time and Minimum Pulses must be realized before the display will update

Adjustment Range: 1 to 99

Default Value: 10

St r t 5

PGM

Startup Suppression

Function: Determines the delay period that will occur after power-up before alarm operation is possible

Adjustment Range: 0 to 99 secs.

Default Value: 0

r t Ent

PGM

Retransmission Enable/Select

Function: Determines whether a voltage/current is an output, and if so, which range

Adjustment Range:

nonE

None

0-5V

0-5 Volts

0-10V

0-10 Volts

0-20A

0-20 mA

4-20A

4-20 mA

Default Value: None

PROGRAM MODE Continued

rt LoL



Retransmission Scale Minimum *(Appears only if a current/voltage is selected)*

Function: Defines the lower end of the linear scale for the retransmission output by defining the value equated to the minimum output signal - i.e. for a 4-20 mA output, this would be the value corresponding to 4 mA

Adjustment Range: 0 to 99999

Default Value: 0

rt HiH



Retransmission Scale Maximum *(Appears only if a current/voltage is selected)*

Function: Defines the upper end of the linear scale for the retransmission output by defining the value equated to the maximum output signal - i.e. for a 4-20 mA output, this would be the value corresponding to 20 mA

Adjustment Range: 0 to 99999

Default Value: 100

CoM75 c



Serial Communication Enabled

Function: Activates the RS-485 communication option board

Adjustment Range:

none

Fitted

None: No communication board installed

Fitted: A communication board is installed in the unit

Default Value: If ordered from the factory with the RS-485 board, the default will be "fitted". If the board is installed in the field, this parameter will need to be changed from its default of "none"

Addr A



Communication Address *(Appears only if communication board is installed and activated)*

Function: Defines the unique communication address of the counter

Adjustment Range: 1 to 99

Default Value: 1

bAud b



Baud Rate *(Appears only if communication board is installed and activated)*

Function: Selects the serial communication speed

Adjustment Range:

1200

2400

4800

9600

1200 BPS

2400 BPS

4800 BPS

9600 BPS

Default Value: 4800

PROGRAM MODE Continued

Color ◦

Display Color Change

Function: Defines the color of the display for prior to and after the preset value is reached

Adjustment Range:

red

Red: The display will always be red

GREEN

Green: The display will always be green

Gr_rd

Green to Red: The display will be green prior to the Alarm value being reached. It will turn red after the Alarm has been reached

rd_Gn

Red to Green: The display will be red prior to the Alarm value being reached. It will turn green after the Alarm has been reached

Default Value: Green to Red



Lock P

Preset Lock

Function: Determines whether the Preset Values can be changed via the front panel

Adjustment Range:

En

Enable: Preset values are read only

dis

Disabled: Preset values can be viewed and changed

Default Value: Disable



HELP h

Help Prompt

Function: Determines whether the multi-character parameter name will appear on the main display for 3 seconds prior to the parameter value appearing

Adjustment Range:

HLP Y

Help - Yes: Multi-character parameter descriptions will appear on the primary display. The value associated with that parameter will appear by pressing the scroll key or waiting for 3 seconds

HLP N

Help - No: Only the parameter values will appear on the primary display. The parameter can be identified by a single digit in the secondary display

Default Value: Help - Yes

A P P E N D I X A

SPECIFICATIONS

Count Inputs

Type: Sinking/Sourcing or Contact Closure
Frequency: 10 kHz max.
Logic: Low \leq 2.0 VDC, High \geq 3.0, 30V max.
Impedance: 10 K Ω to common - Sourcing
4.7 K Ω to +Voltage - Sinking
Magnetic Input: 0.6 to 30V peak

Control Inputs

Type: Sinking, Edge Sensitive
Logic: Low \leq 2.0 VDC, High \geq 3.0
Impedance: 4.7 K Ω to +Voltage
Response Time: 25 ms
Function: Input 1: Display Hold
Input 2: Security Lockout

Outputs

Solid State: NPN open collector, 30 VDC max, 100 mA max.
Relay: SPDT, 5A resistive @ 110VAC
Latency: 75 μ seconds, plus 8 ms for relay pull-in

Linear Outputs

Ranges: 0-20mA, 4-20mA, 0-10V, 2-10V, 0-5V, 1-5V
Accuracy: \pm 0.25% (mA at 250 Ω , V at 2k Ω);
degrades linearly to \pm 0.5%
Resolution: 8 bits in 250ms (10 bits in 1s typ.)
Update: Approximately 4/s
Load Impedence: mA Ranges: 500 Ω max.; V Ranges: 500 Ω min.

Approvals

General: CE
EMC Susceptibility: Complies with EN50082-1: 1992,
EN50082-2: 1995
EMC Emissions: Complies with EN50081-1: 1992,
EN50081-2: 1994
Safety: Complies with EN61010-1: 1993

Communication

Type: Serial asynchronous, UART to UART
Data Format: Open ASCII: One start bit, even parity seven
data bits, one stop bit
Physical Layer: RS-485
Maximum Zones: 99
Baud Rate: Selectable from 9600, 4800, 2400, or 1200

Electrical

Supply Voltage: 90-264 VAC, 50/60 Hz, or 20-50 VAC/VDC
Power Consumption: 4 Watts
Access. Power Supply: 9-15 (unregulated VDC), 125 mA max.

Display

Type: Red/Green, 7 segment LED, 5 digits primary
display, single digit secondary display
Height: 0.71" (18mm) primary display,
0.3" (7mm) secondary display
Annunciators: Output 1 & 2 status

Physical

Dimensions: 48mm x 96mm, 110mm deep
Mounting: Panel mount (mounting bracket supplied),
45mm x 92mm cutout
Terminals: Screw type - combination head
Front Panel Rating: NEMA 4X/IEC IP65
Case Material: GE Lexan 940
Weight: 0.56 lbs.

Environmental

Operating Temp.: 0° to 55° Celsius, 32° to 131° Fahrenheit
Storage Temp.: -20° to 80° Celsius, -4° to 176° Fahrenheit
Relative Humidity: 20% to 95% non-condensing

ORDERING INFORMATION

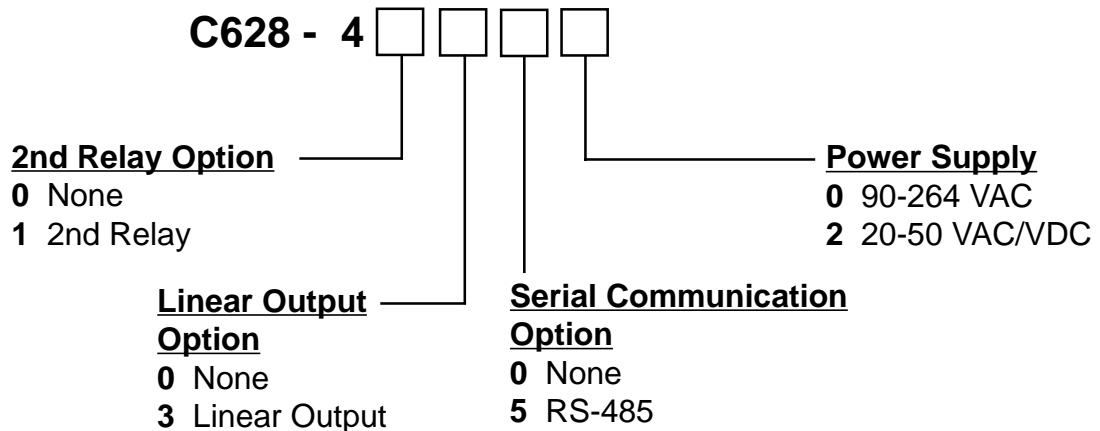

Additional outputs and options can be field installed through plug-in boards which can be ordered separately.

| Description | Part # |
|--------------------|---------|
| Relay Board | T50-001 |
| DC Linear Board | T50-003 |
| RS-485 Comm. Board | T50-005 |

WARRANTY

Standard products manufactured by the Company are warranted to be free from defects in workmanship and material for a period of one year from the date of shipment, and products which are defective in workmanship or material will be repaired or replaced, at the option of the Company, at no charge to the Buyer. Final determination as to whether a product is actually defective rests with the Company. The obligation of the Company hereunder shall be limited solely to repair and replacement of products that fall within the foregoing limitations, and shall be conditioned upon receipt by the Company of written notice of any alleged defects or deficiency promptly after discovery within the warranty period, and in the case of components or units purchased by the Company, the obligation of the Company shall not exceed the settlement that the Company is able to obtain from the supplier thereof. No products shall be returned to the Company without its prior consent. Products which

the Company consents to have returned shall be shipped F.O.B. the Company's factory. The Company cannot assume responsibility or accept invoices for unauthorized repairs to its components, even though defective. The life of the products of the Company depends, to a large extent, upon the type of usage thereof, and THE COMPANY MAKES NO WARRANTY AS TO FITNESS OF ITS PRODUCTS FOR SPECIFIC APPLICATIONS BY THE BUYER NOR AS TO PERIOD OF SERVICE UNLESS THE COMPANY SPECIFICALLY AGREES OTHERWISE IN WRITING AFTER THE PROPOSED USAGE HAS BEEN MADE KNOWN TO IT.

THE FOREGOING WARRANTY IS EXCLUSIVE AND IN LIEU OF ALL OTHER WARRANTIES EXPRESSED OR IMPLIED, INCLUDING, BUT NOT LIMITED TO ANY WARRANTY OF MERCHANTABILITY OR OF FITNESS FOR A PARTICULAR PURPOSE.

Printed in U.S.A.
 702138-0003
 March 1998
 Revision none

Danaher Controls
 1675 Delany Road
 Gurnee, IL 60031-1282
 Phone: 847.662.2666
 Fax: 847.662.6633